

# Sáez

## HT 47

max. Ausladung:	47,00 m
Spitzenlast:	1.200 kg
max. Traglast:	6.000 kg
max. Hakenhöhe:	40,50 m

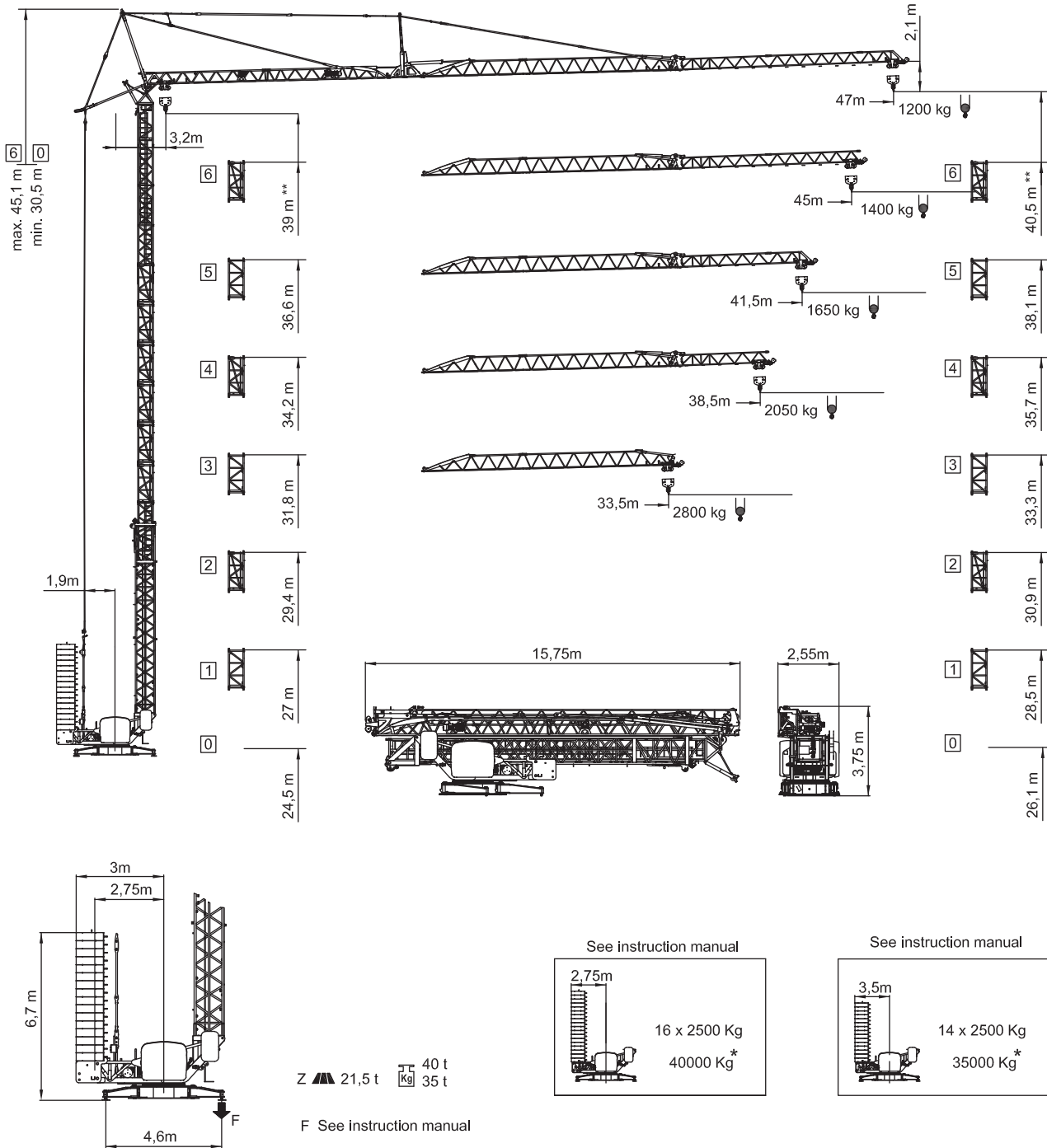

- Dead weight without transport axles and without ballast / Konstruktionsgewicht ohne Transportachse ohne Ballast
- Ballast weight / Ballastgewicht
- \* Ballast weight of erection / Ballastgewicht



**DIN/FEM**

EN 14439-FEM 1005- C25



Angaben gemäß Hersteller. Angaben und Informationen ohne Gewähr. Irrtum und Änderung vorbehalten. Haftung ausgeschlossen. September 2022.





## Lastkurven / Load diagrams

### SUPER LIFT



JIB	12,7	13,6	14	15,7	17,5	18	20	22	24	26	28	30	32	33,5	38,5	41,5	45	47	m
47	6000	5707	5520	4835	4241	4114	3641	3260	2945	2685	2472	2280	2117	2010	1705	1580	1417	1360	Kg
45	6000	6000	5930	5160	4535	4400	3905	3504	3175	2903	2671	2471	2300	2183	1865	1700	1570	Kg	Kg
41,5	6000	6000	5810	5565	4920	4620	4305	3775	3443	3170	3100	2710	2575	2445	2095	1885	Kg	Kg	Kg
38,5	6000	6000	6000	6000	5360	5203	4625	4165	3785	3465	3200	2965	2765	2635	2265	Kg	Kg	Kg	Kg
33,5	6000	6000	6000	6000	6000	5940	5315	4815	4405	4060	3765	3515	3300	3152	Kg	Kg	Kg	Kg	Kg





JIB	12,7	13,6	14	15,7	17,5	18	20	22	24	26	28	30	32	33,5	38,5	41,5	45	47	m
47 m	6000	5510	5320	4640	4047	3920	3450	3070	2760	2500	2290	2100	1940	1833	1535	1410	1254	1200	Kg
45 m	6000	6000	5800	5056	4416	4276	3770	3360	3025	2750	2511	2308	2133	2016	1694	1530	1400	Kg	Kg
42 m	6000	6000	5720	5540	4830	4520	4155	3600	3250	2965	2875	2490	2350	2220	1870	1670	Kg	Kg	Kg
38,5	6000	6000	6000	6000	5248	5084	4485	4007	3615	3285	3010	2772	2565	2430	2050	Kg	Kg	Kg	Kg
33,5	6000	6000	6000	6000	6000	5814	5135	4590	4145	3775	3460	3190	2956	2800	Kg	Kg	Kg	Kg	Kg

## Antriebe / Mechanisms

20Hp (15Kw) INV 400V 50-60Hz					
	m/min	12	25	45	65
	Kg	6000	3000	1500	500
	Kw	15			
	m/min	15	35	50	
	Kw	4,5			
	r.p.m	0,25	0,5	0,8	
	N.m.	30			
	Kw	9			

### 20Hp (15Kw) - INV

		400V 50Hz I <sub>max</sub> = 72A Fuse= 80A	TOTAL POWER 22 KVA	GENERATOR 75 KVA	100m 4x25mm <sup>2</sup>	150m 4x35mm <sup>2</sup>	200m 4x35mm <sup>2</sup>
2000/14/CEE 2005/88/CEE	2006/95 /CEE	480V 60Hz I <sub>max</sub> = 60A Fuse= 70A					

-  Elevación / Hoisting / Heben / Levage / Sollevamento
-  Distribución / Trolleying / Katzfahren / Distribution / Distributions
-  Orientación / Slewing / Schwenken / Orientation / Rotazione
-  Montaje / Erection / Montage / Montage / Montaggio

**Transport / Transport**

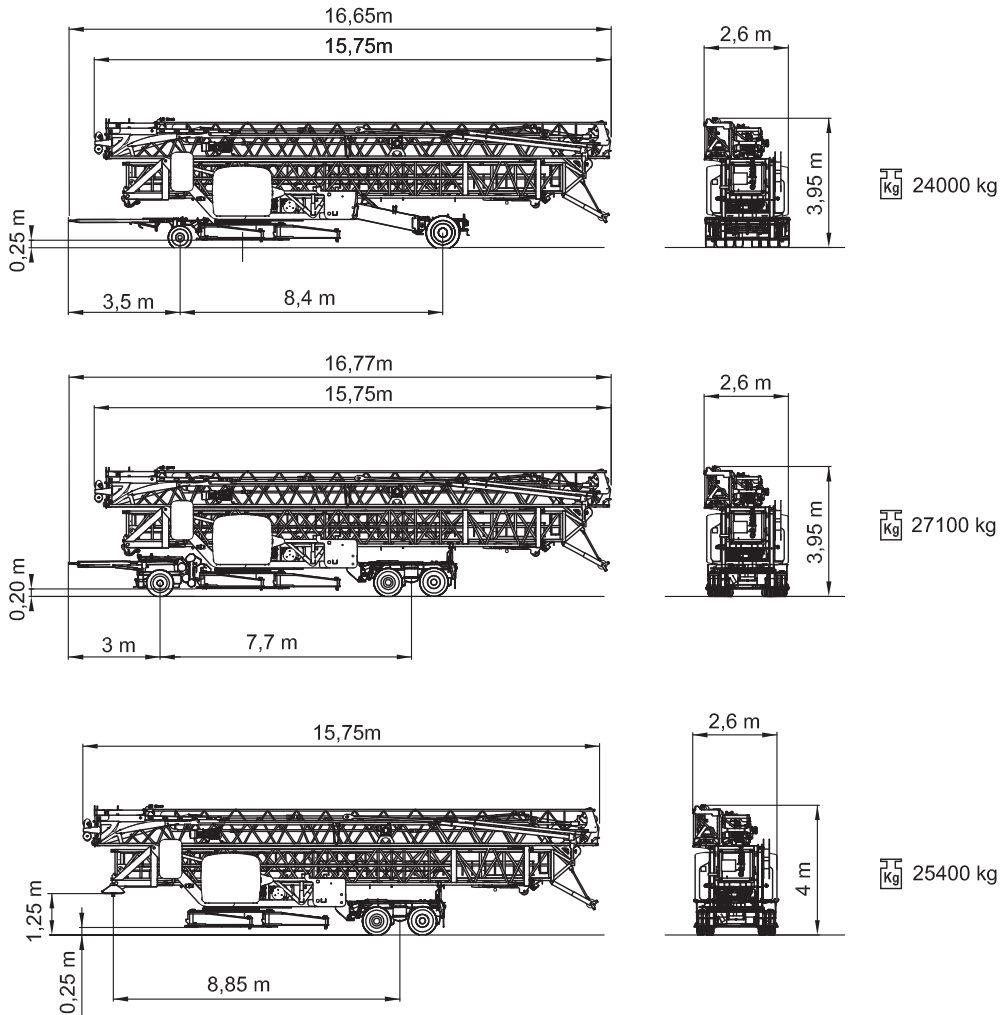



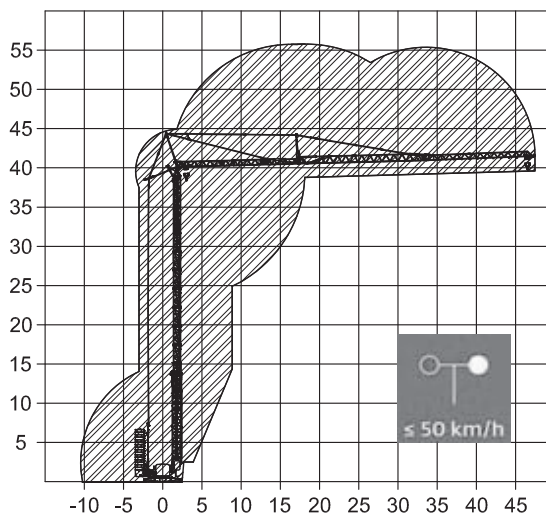





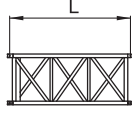
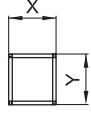
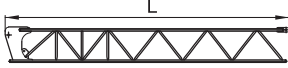

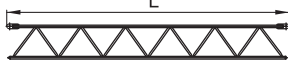

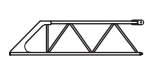

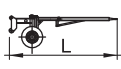



**Aufstellvorgang / Erection procedure**

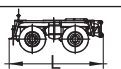

Angaben gemäß Hersteller. Angaben und Informationen ohne Gewähr. Irrtum und Änderung vorbehalten. Haftung ausgeschlossen. September 2022.

**Abmessungen / Dimensions**

Pos. Item	Anz. Qty.				L (m)	X (m)	Y (m)	kg
1	4	Tower section / Turmstück			2,4 m	0,94 m	1 m	485
2	2				2,4 m			560
3	1	Jib extension (T3.1) / Ausleger-Verlängerung			5,47 m	0,8 m	0,7 m	305
4	1	Jib extension (T3.2) / Ausleger-Verlängerung			5,47 m	0,8 m	0,69 m	235
5	1	Jib extension (T3.3) / Ausleger-Verlängerung			2,6 m	0,8 m	0,69 m	105
6	1	Road transport axle front / Transportachse vorne			3,55	4,15 m	1,15 m	935
7	1	Road transport axle front / Transportachse vorne			3,8 m	2,5 m	1,30 m	1920
8	1	Road transport axle behind / Transportachse hinten			1,90 m	2,5 m	1,05 m	1100
9	1	Road transport axle behind / Transportachse hinten			3,10 m	2,5 m	1,10 m	1920
10	1	Road transport axle behind / Transportachse hinten			3,00 m	2,5 m	1,20 m	2550
11	1	Road transport axle behind / Transportachse hinten			3,00 m	2,5 m	1,20 m	3000

Angaben gemäß Hersteller. Angaben und Informationen ohne Gewähr. Irrtum und Änderung vorbehalten. Haftung ausgeschlossen. September 2022.